

MAGUS 2.1

Innovation of Magnet track
2023

Succeed in working with Magus

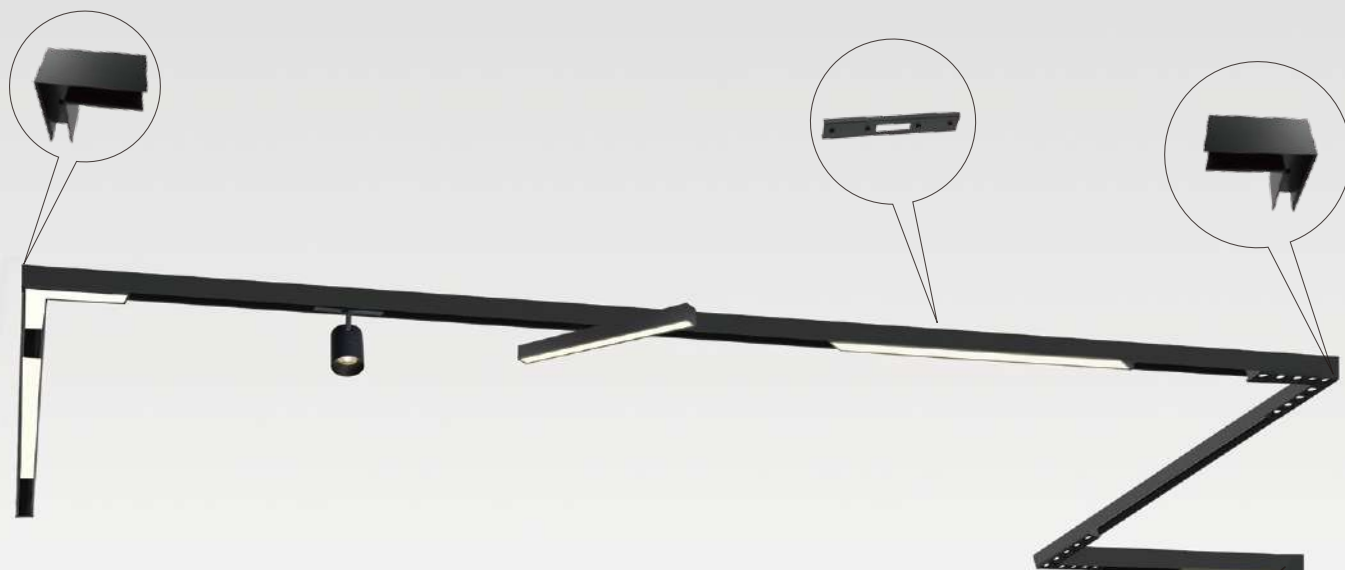

Buckingham magnet track system advantages:

- UNIVERSAL system operates for non-dim / 0-10V dim / Triac dim function, ALL-in-ONE system allows inventory reduction.
- Connector-Free in system, less cost and less work in field, free of trouble.
- Power-feed connector free in system, power works with track directly at anywhere in system.
- Polarity-free, fixtures designed with polarity free for reversed installation, no mistake in field, trouble free. (patented)
- Free-lay-out in system, fixtures can be installed at anywhere of track because of no connectors.
- Ease of installation via screw holes set up on track, less work in field.
- installation in system, Suspension, Surface Mounted, Flanged Recessed and Muddy Trim-less Recessed for all kinds of application.
- 48V low voltage in safety installation, 240W maximized large number of fixtures.



Power option



FMAG48-100 – non dime 100 W
FMAG48-100T –Triac dime 100 W
FMAG48-100V – 0-10V dime 100 W



FMAG48-150 – non dime 150 W
FMAG48-150T –Triac dime 150 W
FMAG48-150V – 0-10V dime 150 W



FMAG48-200 – non dime 200 W
FMAG48-200T –Triac dime 200 W
FMAG48-200V – 0-10V dime 200 W



FMAG48-240 – non dime 240 W
FMAG48-240T –Triac dime 240 W
FMAG48-240V – 0-10V dime 240 W

Driver Box

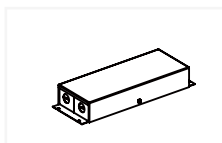

MT5151



- The simplicity of Magnetic Track System is designable for general lighting or task lighting by various selected fixtures, linear fixtures or directional task heads.
- With connector-free, system can be very easy surface mounted, recessed or suspended as the lighting designers' planned lay-out with non-limitation.
- System fits for most of commercial places, likes Office Spaces, Display Areas, Retail Stores, Public Spaces.
- Low 48 Voltage designed for easy installation insafety.
- Magnetic adaptor allows fixtures be replaced at anytime and anywhere.

Suspension System (Universal for non-dim, 0-10V dim and Triac dim function)

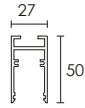
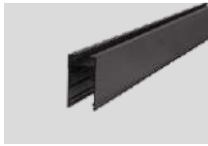

Name	Code	Length
Track	MT502-050	0.5M
	MT502-100	1M
	MT502-200	2M
	MT502-300	3M

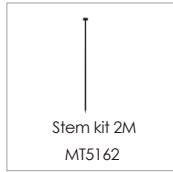

Surface mounted System (Universal for non-dim, 0-10V dim and Triac dim function)



Recessed Flanged System (Universal for non-dim, 0-10V dim and Triac dim function)

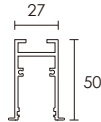

Name	Code	Length
Flanged Track	MT502T-050	0.5M
	MT502T-100	1M
	MT502T-200	2M
	MT502T-300	3M

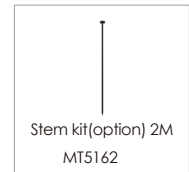

Recessed Muddy System (Universal for non-dim, 0-10V dim and Triac dim function)

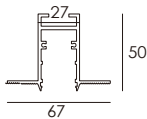

Name	Code	Length
Trimless Track	MT502S-050	0.5M
	MT502S-100	1M
	MT502S-200	2M
	MT502S-300	3M



Common Components

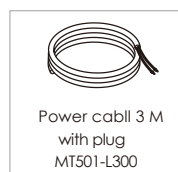



- Aluminum die cast with fine machining and powder coating.
- Ease of replace accessories by release front ring.

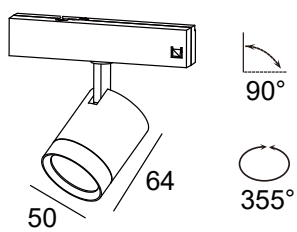

LED	DC 48V	IP20	CRI >90
-----	-----------	------	------------



Code	Watts	CCT	Lumens	Beam
------	-------	-----	--------	------

MT5301N	10 W	3000 K	630 lm	16°/26°
----------------	------	--------	--------	---------

Accessory

MT5301L-002 Long Shoot: Antiglare

MT5301-002AG Chess Lens

MT5301-002AB Honey Comb Louver





·Aluminum die cast.

·High output efficacy 86lm/w.

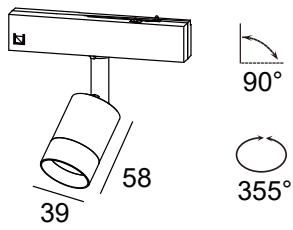

LED	DC 48V	IP20	CRI >90
-----	-----------	------	------------



Code	Watts	CCT	Lumens	Beam
------	-------	-----	--------	------

MT5302N	5 W	3000 K	430 lm	16°/24°/38°/60°
----------------	-----	--------	--------	-----------------



- Small aperture designed with tubular long shade.
- Elegant, soft light for emotional environment.

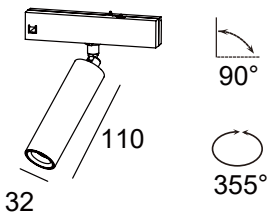

LED	DC 48V	IP20	CRI >90
-----	-----------	------	------------



Code	Watts	CCT	Lumens	Beam
------	-------	-----	--------	------

MT5416	5 W	3000 K	310 lm	26°
---------------	-----	--------	--------	-----



- Aluminum die cast with fine powder coating.
- Anti-glare designed suitable for shop and display.

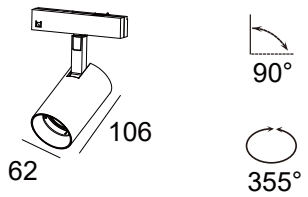

LED	DC 48V	IP20	CRI >90
-----	-----------	------	------------



Code	Watts	CCT	Lumens	Beam
------	-------	-----	--------	------

MT5303	15 W	3000 K	680 lm	10°/20°/30°
---------------	------	--------	--------	-------------



50°

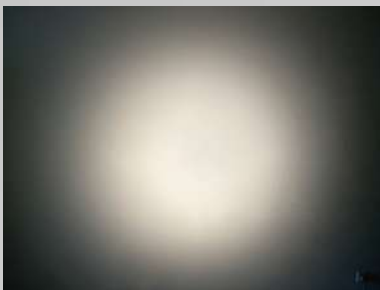

15°



- Designed adjustable beam from 10 to 40 degree.
- 6W tiny aperture designed for display or task lighting.

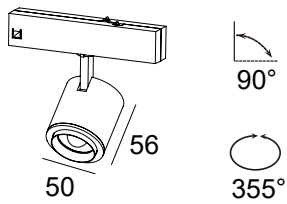

Adjustable beam



LED	DC 48V	IP20	CRI >90
-----	-----------	------	------------



Code	Watts	CCT	Lumens	Beam
------	-------	-----	--------	------

MT5304	6 W	3000 K	420 lm	10°~40°
---------------	-----	--------	--------	---------



60°

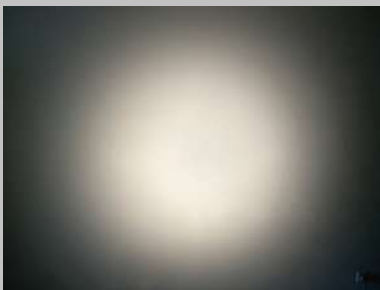

20°



·Aluminum die casting with fine powder coating.

·15w with adjustable beam function designed for shop and access lighting.



Adjustable
beam

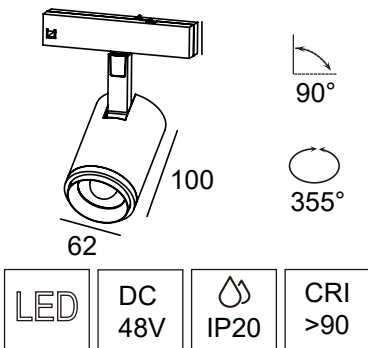

Code	Watts	CCT	Lumens	Beam
------	-------	-----	--------	------

MT5305	15 W	3000 K	680 lm	15°~55°
---------------	------	--------	--------	---------



·Flexible assembly for 2 by 2, 3 by 2, 4 by 2.

·Very tiny, with high efficacy 81lm/w to be excellent on general light. Glare less.

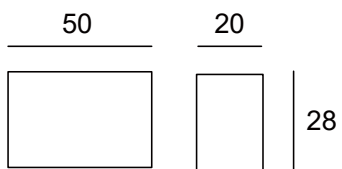

LED	DC 48V	IP20	CRI >90
-----	-----------	------	------------



Code	Watts	CCT	Lumens	Beam
MT5204N	4 W	3000 K	324 lm	30°



- Design with linear dot 6 and 12 spot with glare less.
- Function in general lighting.

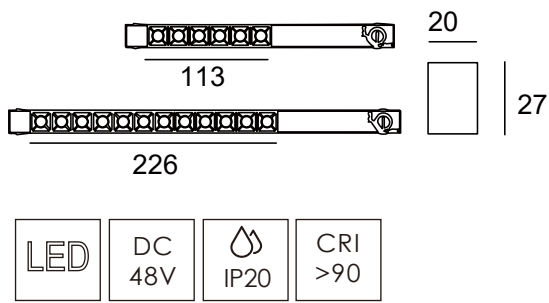

Code	Watts	CCT	Lumens	Beam	Specifications
MT52201	6W	3000 K	300 lm	20°/40°	6 cells
MT52202	12W	3000 K	600 lm	20°/40°	12 cells

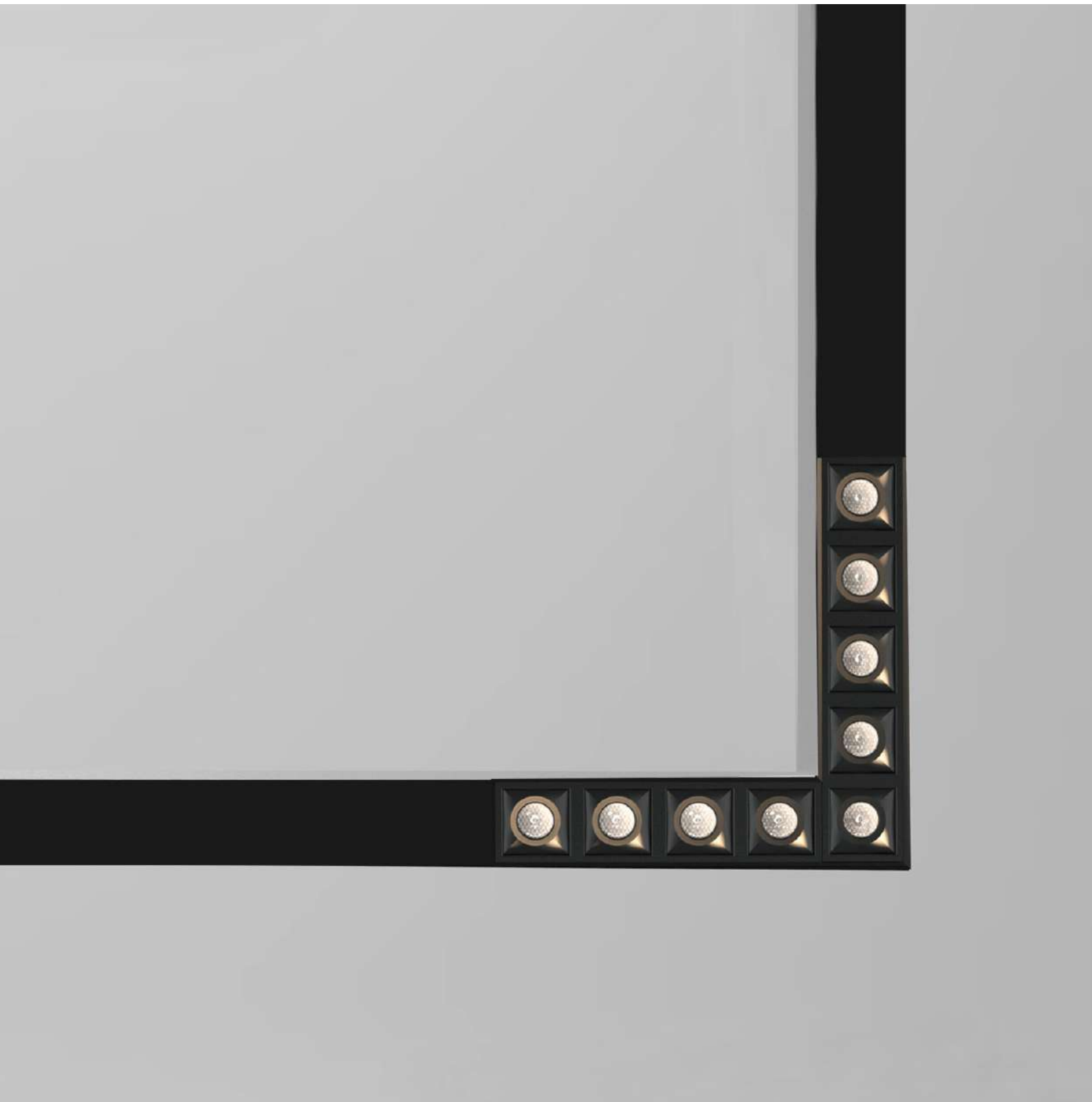

- Elbow design for corner element.
- 10 w provides 900 lm output, 90lm/w efficacy.

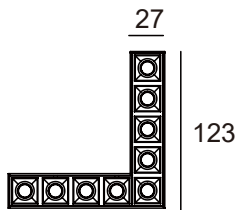

LED	DC 48V	IP20	CRI >90
-----	-----------	------	------------

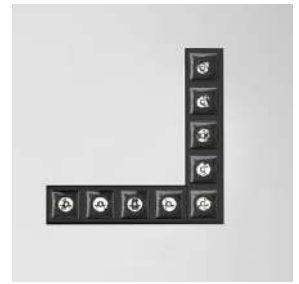

Code	Watts	CCT	Lumens	Beam	Specifications
MT5207	10 W	3000 K	900 lm	20°/40°	9 cells

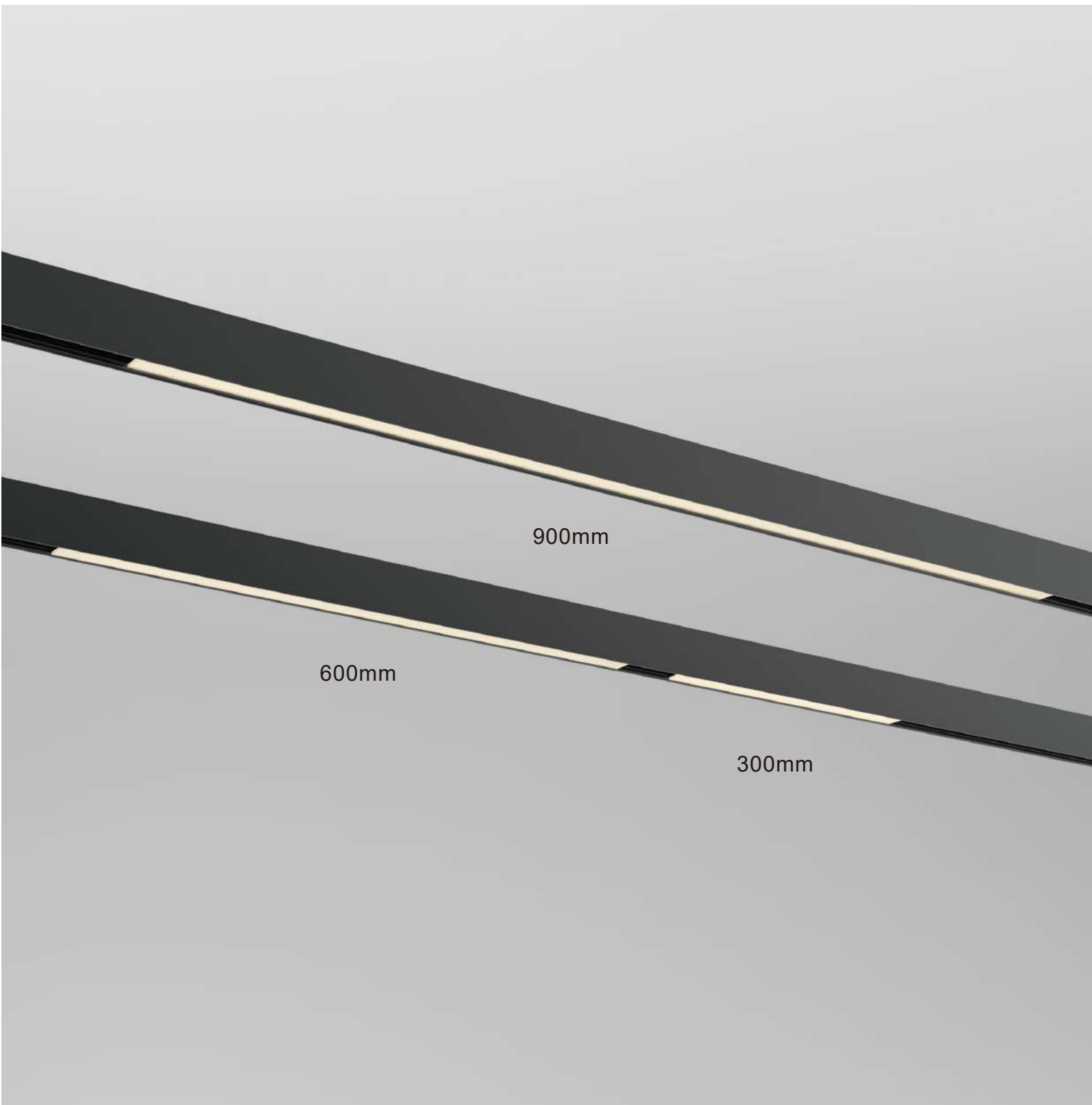

- Slim and invisible linear design, provides general light.
- Designed in 300mm, 600mm and 900 mm 3 sizes.

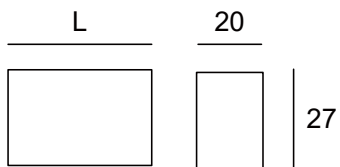

LED	DC 48V	IP20	CRI >90
-----	-----------	------	------------



Code	Watts	CCT	Lumens	Beam	L
MT52213	14 W	3000 K	630 lm	100°	321 mm
MT52216	28 W	3000 K	1260 lm	100°	621 mm
MT52219	42 W	3000 K	1890 lm	100°	921 mm

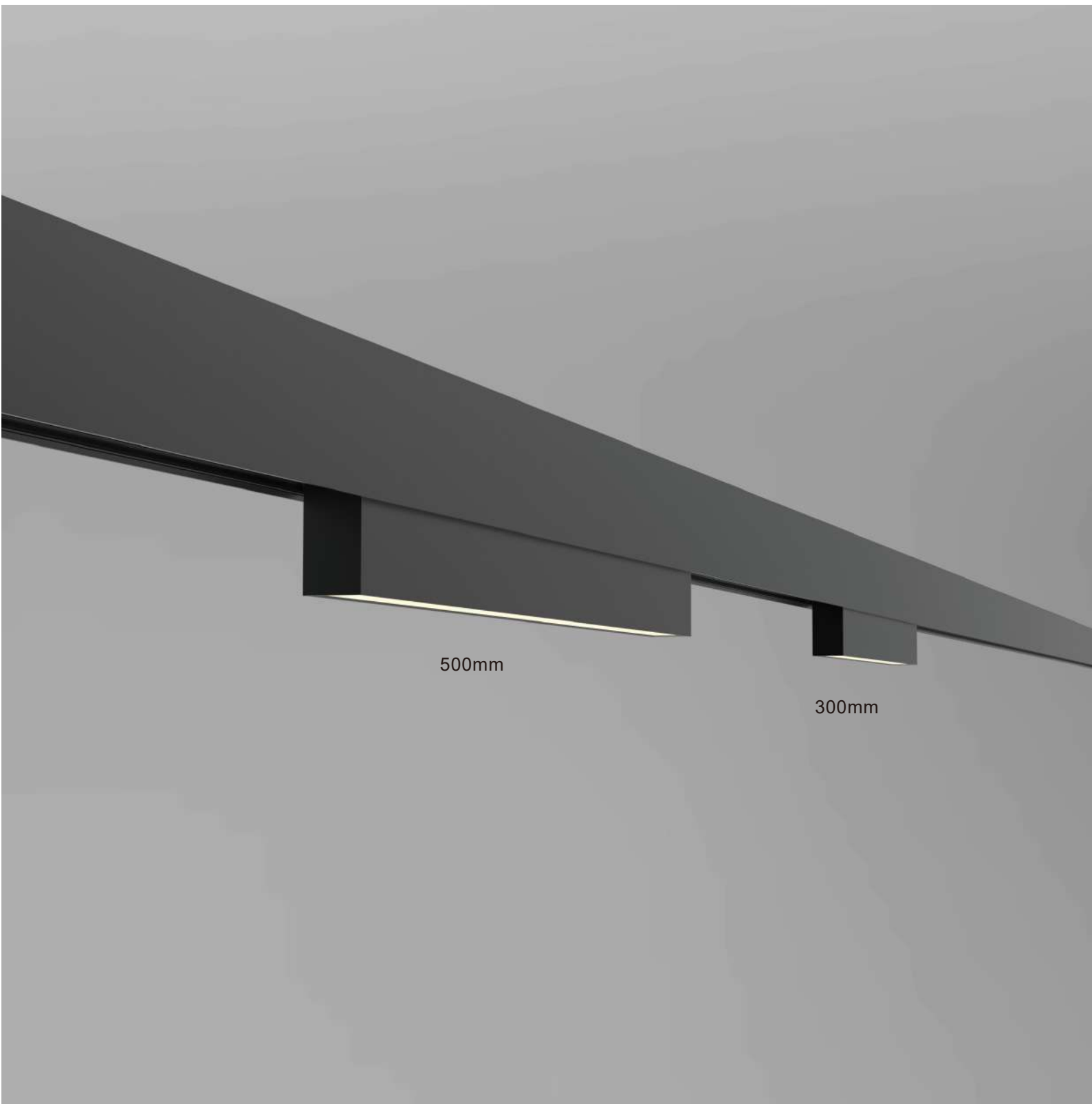

- Designed with 78mm height, 300mm and 500mm length,
- Decorative function immerses into environment.

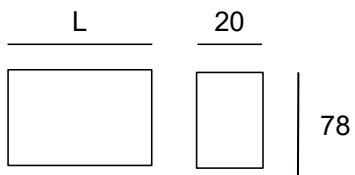

LED	DC 48V	IP20	CRI >90
-----	-----------	------	------------



Code	Watts	CCT	Lumens	Beam	L
MT5203N	14 W	3000 K	960 lm	100°	300 mm
MT5253N	22 W	3000 K	1400 lm	100°	500 mm



·Swivel and functional design for task light.

·300mm and 500mm 2 sizes for option.

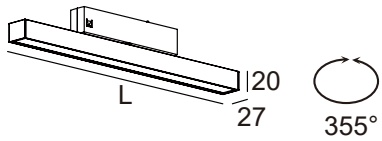

LED	DC 48V	IP20	CRI >90
-----	-----------	------	------------



Code	Watts	CCT	Lumens	Beam	L
MT5506	14 W	3000 K	700 lm	100°	300 mm
MT5507	22 W	3000 K	1400 lm	100°	500 mm



·Wall washer designed for flush environment.

·300mm and 600mm length in option.

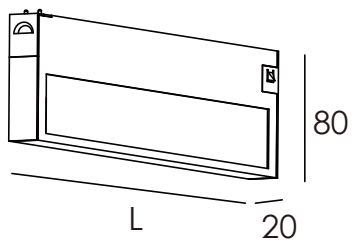

LED	DC 48V	IP20	CRI >90
-----	-----------	------	------------

Wall washer



Code	Watts	CCT	Lumens	Beam	L
MT5501	14W	3000K	700 lm	40~70°	300mm
MT5502	28W	3000K	1400 lm	40~70°	600mm



·90 degree swivel and 355 degree rotation.

·Functional design for shop and display.

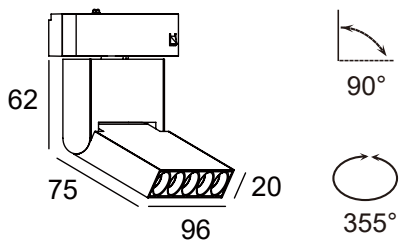

LED	DC 48V	IP20	CRI >90
-----	-----------	------	------------



Code	Watts	CCT	Lumens	Beam
MT5401	7 W	3000 K	510 lm	26°



- High lumen output to 1400lm with silky soft light.
- Excellent general light in large space.

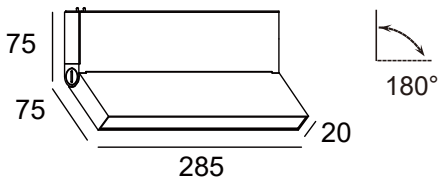

LED	DC 48V	IP20	CRI >90
-----	-----------	------	------------



Code	Watts	CCT	Lumens	Beam
------	-------	-----	--------	------

MT5213N	22 W	3000 K	900 lm	100°
----------------	------	--------	--------	------



- Tiny aperture 30mm only, tubular design with 300mm, 600mm, and 900mm length,
- 1.5M cable to be adjustable by ease of cutting cable in adaptor.
- Designed for bar or somewhere needs very soft light.

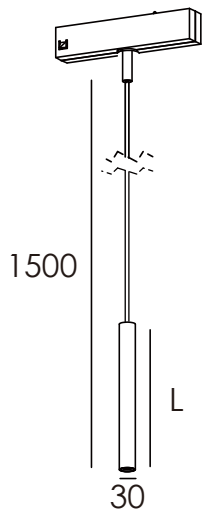

LED	DC 48V	IP20	CRI >90
-----	-----------	------	------------



Code	Watts	CCT	Lumens	Beam	L
MT5421P	5 W	3000 K	300 lm	26°	300mm
MT5422P	5 W	3000 K	300 lm	26°	600mm
MT5423P	5 W	3000 K	300 lm	26°	900mm



- Crystal clear surface with frost underneath PMMA lamp shade creates even soft light.
- Flush general light, perfect selection for island table, long bar, home decorative.
- 1.5M cable to be adjustable by ease of cutting cable in adaptor.

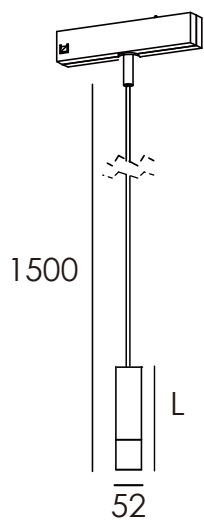

LED	DC 48V	IP20	CRI >90
-----	-----------	------	------------



Code	Watts	CCT	Lumens	Beam	L
------	-------	-----	--------	------	---

MT5417P	7 W	3000 K	300 lm	120°	210 mm
----------------	-----	--------	--------	------	--------

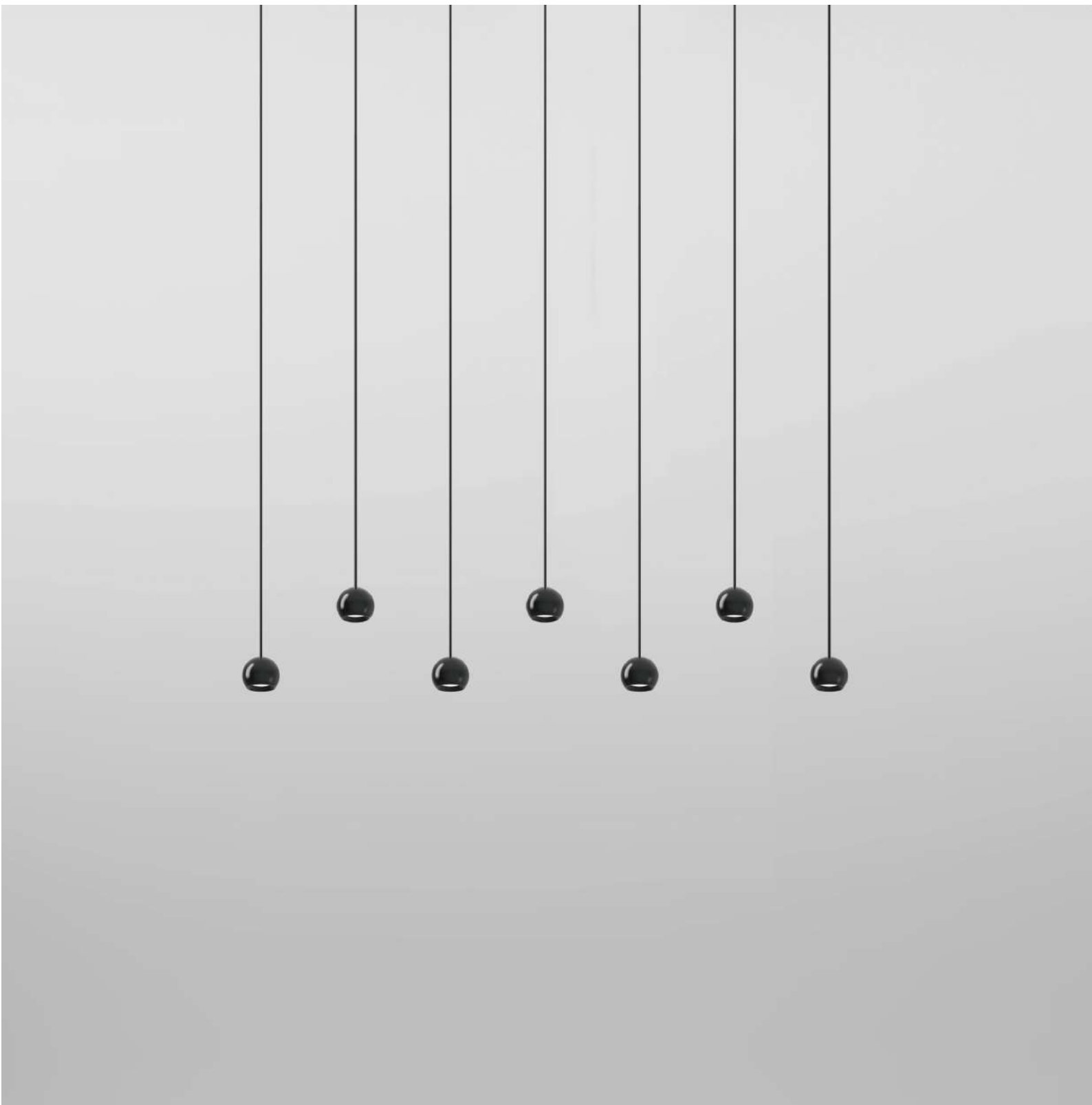

- Silky and dim light for very soft emotion.
- Small aperture 34 mm dia. only, cute design.

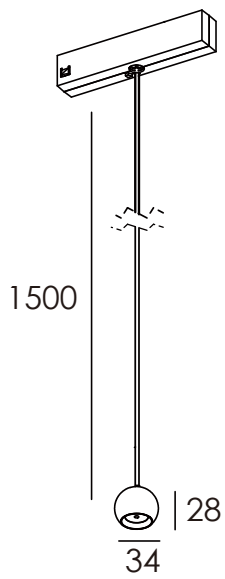

LED	DC 48V	IP20	CRI >90
-----	-----------	------	------------



Code	Watts	CCT	Lumens	Beam
------	-------	-----	--------	------

MT5418	3 W	3000 K	200 lm	26°
---------------	-----	--------	--------	-----



- Glory design, with flush light suitable for island table.
- 1.5M cable to be adjustable by ease of cutting cable in adaptor.

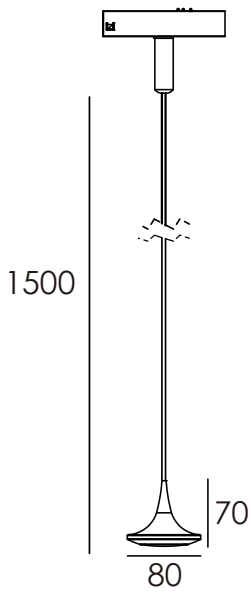

LED	DC 48V	IP20	CRI >90
-----	-----------	------	------------



Code	Watts	CCT	Lumens	Beam
------	-------	-----	--------	------

MT5419P	8W	3000 K	560 lm	120°
----------------	----	--------	--------	------



- Disc shade with 15w 900 lm suitable for larger place.
- 1.5M cable to be adjustable by ease of cutting cable in adaptor.

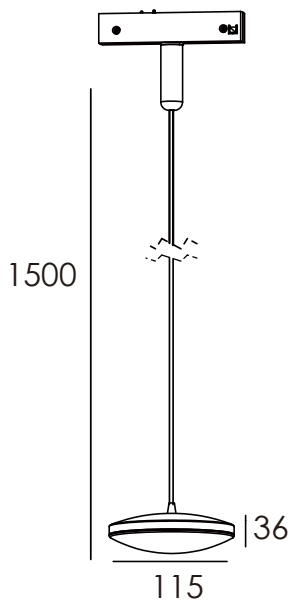

- LED
- DC
48V
- IP20
- CRI
>90

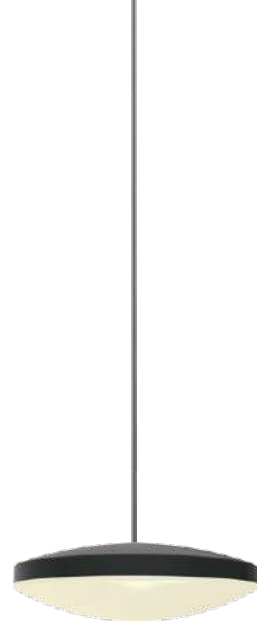

Code	Watts	CCT	Lumens	Beam
MT5420P	15 W	3000 K	900 lm	120°



www.buckingham.com.tw

Buckingham Taiwan Factory

Address

8Fl, No.659-5, Chung Cheng Road,
Hsin Chuang Destrict, New Taipei City,
Taiwan

Postcode

24257

Phone

+886-2-2903 7898

Fax

+886-2-2903 7698

E-mail

sales @ buckingham.com.tw

Buckingham China Factory

Address

No. 89, Feng Shou East Road,
Qian Deng Town, Kun Shan City,
Jiang Su, China

Postcode

215343

Phone

+86-512-5740 7561

Fax

+86-512-5740 7562

E-mail

sales @ buckingham.com.tw

2022.10.24